

AH3D-DM

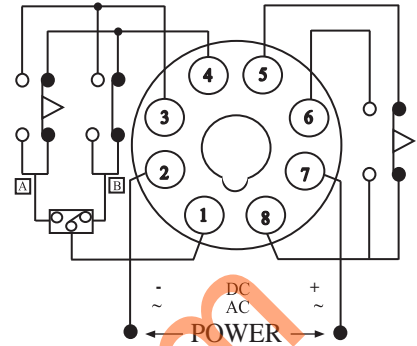

Dimension (mm) : 50H×40W×57.5D
 Contact Rating : 250VAC 5A Resistive Load
 : 48VDC 5A Resistive Load
 Reset Time : 0.1 sec max
 Consumed Power : 3VA
 Ambient Temperature : -10°C ~ +55°C
 Ambient Humidity : 45~85%RH
 Mechanical : 5×10⁶ Times
 Electrical : 10⁵ Times
 Frequency : 50/60Hz
 Weight : 160g

Connection



Model	Time Range	Supply Voltage	Price
AH3D-DM	.59S, 99S, 9.9S, 99S, .59M 9.9M, 99M, 9.9H, 99H, 990H	220VAC	400.-

AH3D-D2





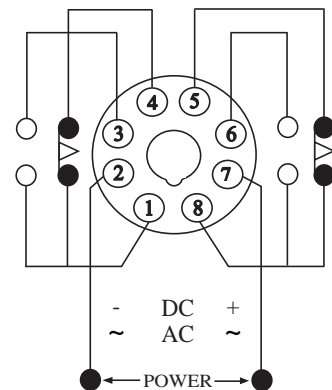

Dimension (mm) : 50H×40W×57.5D
 Contact Rating : 250VAC 5A Resistive Load
 : 48VDC 5A Resistive Load
 Reset Time : 0.1 sec max
 Consumed Power : 3VA
 Ambient Temperature : -10°C ~ +55°C
 Ambient Humidity : 45~85%RH
 Mechanical : 5×10⁶ Times
 Electrical : 10⁵ Times
 Frequency : 50/60Hz
 Weight : 130g

Connection

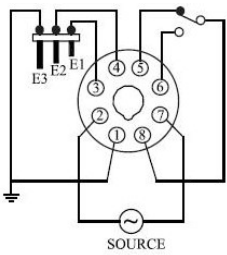

Model	Time Range	Voltage	Price
AH3D-D2	9.9S, 99S	220VAC	385.-
AH3D-D2	9.9M, 99M		
AH3D-D2	9.9H, 99H		

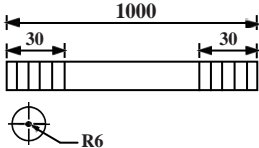
Model	Dimension	Specification		Price
C61F-GP 		Floatless Relay	VAC : 110 , 220	490.-
AFR-1 				520.-
PS-3S 		Electrode Holder	3 PIN	145.-
PS-4S			4 PIN	320.-
PS-5S			5 PIN	350.-
PS-N 		Electrode Nut		20.-
PS-1M 		Electrode S.Steel	One Meter	120.-

www.adkri.com